



Image for demonstration purposes

Generating Set
RENTAL BUILDING - Diesel

GE.YAS5.022/020.RB+011

1500 rpm - Trifase - 50Hz - 400V
 Automatic panel without switching on board



Standard equipment

Canopy Soundproofing

Removable soundproof canopy
 Painting canopy (RAL) in galvanized sheet steel
 Soundproofing with class 1 polyester material
 Handles with key lock and automatic closing
 Special baffles for air intake and air expulsion
 Inspection doors with hermetic gasket
 Automatic doorstop
 Externally and internally washable with sprayer

Exhaust

Residential exhaust system -35dB(A)
 Exhaust rain cap
 Insulated exhaust pipes
 Internal residential muffler - 35dB(A)

Fuel Supply

Single wall daily tank with 110% bunded base
 Plug & Play fuel connections
 Bulk tank connections with 3 way valve
 Automatic shutdown system for low fuel level
 Fuel gauge
 Mechanical fuel gauge
 Increased fuel hatch for washing

Handling

Oversized lifting hook
 Base frame with anti-overturning forklift pockets
 Loadable side by side for truck transportation
 Rubber Bumpers

Base Frame

Bunded base at 110% of fuel tank capacity
 Anti-vibrating mounting pads
 Battery compartment externally accessible for easy service

Engine

High coolant temperature and low oil pressure shutdown system
 Oil change pump
 Engine liquids (oil and antifreeze)
 Tropicalized radiator
 Rotating parts protection
 Battery disconnecter lockable

Alternator

AVR Automatic Voltage Regulator
 Impregnation for marine environment
 IP23

Panel & connection

Emergency Stop button
 Non-Automatic circuit breaker on panel board
 RCD with adjustable current and excludible
 Tamperproof panel IP55
 Cable output from rear
 IP44 wiring
 Start-up battery (pre-charged)
 Plug & Play connector for Bus communication between controller (Only variant +14)
 Sockets module with magnetothermal circuit breaker and Differential
 Grounding point

Documentation

CE conformity declaration
 User and Maintenance manual
 Test report
 Wirings diagrams
 IP 55 Document pocket
 Exploded drawing with spare parts codes

Normatives

All Generating sets are compliant to CE Marking
 2014/30/UE Electromagnetic compatibility
 2000/14/CE Noise Emission for outdoor use
 Factory-designed systems built according to ISO 9001:2015
 CEI EN 60204-1:2018 - Electrical equipment of machines

Primary data

General Information

Speed	RPM	1500
Frequency	Hz	50
PRP - Prime power	KVA	20
LTP - Standby power	KVA	22
PRP - Prime power	KW	16
LTP - Standby power	KW	17,6
Standard Voltage	V	400/230
Current	A	28,9
Voltage for current calculation	V	400
COSFI	0,8	0,8

General electrical protection

Rated current	A	63
Type	Non-Automatic circuit breaker on panel board	
Poles	N	4P
Optional/notes	Opening coil	
Additional protection	Adjustable and excludable Differential protection	
Protection device	Control module	
Adjustments tripping set-point (I _d)	mA	30 - 5000
Adjustments tripping time (t)	sec.	0 - 30

Noise level +/- 3dB(A)

LWA	dB(A)	82
Sound pressure level @ 7 mt	dB(A)	57
Sound pressure level @ 1 mt	dB(A)	66

Fuel Consumption

TYPE	Diesel	
Standard Fuel Tank capacity	lt	110
Autonomy @ 75% load	h	28
Fuel consumption at 100% load	lt/h	5,4
Fuel consumption at 75% load	lt/h	4
Fuel consumption at 50% load	lt/h	2,9

General data

Rated capacity	Ah	1x70
Auxiliary Voltage	V	12
Exhaust diameter	mm	60

Weight and Dimensions

Dimensions (L x W x H)	cm	195x95x150
Weight with liquids (excluding optionals and fuel)	Kg (+/-3%)	779

⚙️ Engine

Factory		Yanmar
Model		4TNV88
Emissions stage		Stage 5
Speed governor		Mechanic
Radiator	°C	50
Cooling	Tipo	liquid (water + 50% Paraflu11)
Active net power	Kwm	18
Nominal net power	CV	24,5
Cycle	Tipo	4 strokes
Injection	Tipo	Direct
Aspiration	Tipo	Natural
Numbers of cylinders	N	4
Cylinders arrangement		L
Bore	mm	88
Stroke	mm	90
Total displacement	lt	2,188
Engine oil features		15W40-API CI-4/CH-4 ACEA E5-E7
Total oil capacity	lt	7,4
Total coolant capacity	lt	7,5

⚙️ Alternator

*** May vary based on stock availability. However, a primary brand will be used.**

Factory		Stamford
Model		SOL2-G1
PRP continuous power	KVA	20
Voltage Regulator (voltage accuracy)	+/- %	1
Poles	N°	4
Phases	N°	3+N
Standard windings connection		Star Series
Stator/rotor impregnation		H (Outdoor Temp 40°C)
Efficiency	%	86,8
Engine coupling		Elastic disk
Short circuit current		3x In (only with winding wdg 711)
Protection degree	IP	23
Cooling system		Self ventilating
Maxium overspeed	rpm	2250
Waveform distortion	%	<5
Exciter		Diode bridge

⚙️ Environmental conditions

Ambient temperature	°C	40
Relative Humidity	%	60
Max altitude	mt	1000

Control Systems on board QPE-C-SC-3F-4P-32-01RB

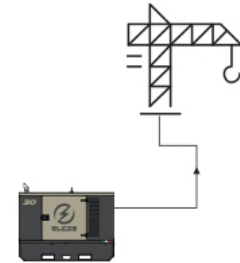

operating scheme - schema di funzionamento

QPE Automatic panel without switching on board

The QPE-C control panel represents the evolution of the panel for the control and management of the gen set. With its microprocessor logic it is able to meet any user requested features. The dual operation mode manual and automatic guarantees to every type of functionality protection, analysis and control of the generating set in order to make the management easy and efficient. Variant without transfer switch on board. ATS panel type QC as optional. The panel manages the QC panels directly or any other ATS panel.

Mechanical features

Protection degree	<i>IP</i>	55
-------------------	-----------	-----------

Battery charger

Model		ELCOS - CB1
Maximum output current	<i>A</i>	2,5
Output DC voltage (selectable)	<i>V_{dc}</i>	12-24
Input AC voltage (selectable)	<i>V_{ac}</i>	220-260
Frequency	<i>Hz</i>	50-60

Sockets module

Protection	<i>Type</i>	Differential Magnetothermal breakers
Differential Sensivity	<i>mA</i>	30 (only for 16A and 32A)
Sockets		N. 1 CE Schuko 16A 230V
Sockets		N. 1 CE 2P+T 16A 230V
Sockets		N. 1 CE 3P+N+T 16A 400V
Sockets		N. 1 CE 3P+N+T 32A 400V
Male socket		N. 1 CE 2P+T 16A 230V

Data Communication

Data connection port		RS-485
Communication protocol		Mod-bus RTU-8N1

Remotable functions in terminal box

GS start	GS lock
Genset contactor close/open command (1)	Mains contactor close/open command (2)
Common Alarm - DC output	GS test without load

GS start with key in OFF position (Only in MRS mode)

Programmable output - Volt free output

Control Module



Model	MC4
Operating mode	AMF - MRS

Specifics

Applications

Emergency to the Mains
Stand-alone
Construction site/Rental
Self-production

ENGINE MEASURES

Fuel tank level %
Engine oil pressure BAR (1)
Engine Coolant temperature °C (1)
Total run time
Partial run time
Hours to maintenance
Battery voltage
Battery charging voltage
Start-ups counter
Engine speed (2)
Engine Oil temperature (2)
Cooler temperature (2)
Engine oil level (2)
Engine coolant level (2)
Engine coolant pressure (2)
Turbo pressure (2)
Fuel Consumption (2)
Tank autonomy - hrs (5)
Fuel remaining quantity (5)
Fuel used quantity (5)

ALTERNATOR MEASURES

Generator Voltage L1, L2, L3
Generator Voltage L1-N, L2-N, L3-N
Generator frequency
Generator current L1, L2, L3
Generator Apparent Power kVA
Generator Active Power kW
Generator Reactive Power kVAR
Generator accumulated power kWh
Power factor Cosφ

MAINS MEASURES

Mains voltage L1, L2, L3
Mains voltage L1-N, L2-N, L3-N
Mains frequency

COMMUNICATION PORTS

Can-bus port
RS485 port with Mod-bus RTU communication
RS232 port for display connection
USB port for parameters saving and firmware update

EQUIPMENT

Microprocessor Logic
Back-lit display
Programmable from display
16 event log
Multiple display languages
STOP button
START button
TEST button
Reset alarm button
Alarm mute button
Fuel transfer pump activation button
Glow-plug activation button

PRE-ALARMS/ ALARMS

Common Alarm
Fuel reserve (pre-alarm)
Low fuel level (alarm)
Tank overflow
Charge alternator failed (dinamo)
Low oil pressure (pre-alarm) (1)
Low oil pressure (alarm)
Oil sensor failed (alarm)
High coolant temperature (pre-alarm) (1)
High coolant temperature (alarm)
Low coolant temperature (pre-alarm)
Low water level (1)
Water in fuel (1)
Battery undervoltage
Battery overvoltage
GS failure to start
GS failure to stop
Can-bus Failure
No Can-bus communication
Genset overload L1, L2, L3 phases
Genset short circuit
Genset overvoltage
Genset undervoltage
Genset high frequency
Genset low frequency
overspeed
Reverse power
Earth fault (pre-alarm)
Earth fault (alarm)
Block from password
CAN communication Failed
Maintenance request
Emergency button pressed
Remote emergency active
Forced stop
External battery failed
Fuel theft
Genset negative phase sequence
Mains negative phase sequence
Fuel theft protection

VISUALIZATIONS ON CONTROL MODULE/DISPLAY

Pre-alarms
Alarms
Engine measures
Alternator measures
Mains measures
Date and time
Operating mode
Genset status
Mains status
Mains contactor status
Genset contactor status
Digital Input and Output status
Grounding current mA (3)
Grounding current threshold mA (3)
Delay time of differential protection (3)
Glow plugs status

CONTROL MODULE FUNCTIONS

Automatic start and stop when the Mains Fails (7)
Remote Start and Stop
Remote Start and Stop with key in OFF position
Manual Start and stop
Emergency stop button on panel board
Remote emergency stop
Remote lock
Remote test without load
Remote test on load
Scheduled start-ups
MODBUS commands (Start, Stop, Reset, Test)

CONTROL MODULE SPECIAL FUNCTIONS (on demand)

Automatic charging of an external battery
Dummy load (4)
Load shedding (4)
Redundant starter motor management
Fuel monitoring
GS battery Load test
Idle mode
Service phone number indication
Variable speed Generator
Master / Slave mode

(1) Present only with the sensor installed on engine (optional)

(2) Present according to the engine equipment and to the ECU type (ECU - Canbus)

(3) Present only with the residual current device mounted on genset board

(4) Present with optional expansion modules







(5) Present with special function activated

(6) Only with the optional of the automatic fuel refilling system on board

(7) Only in AMF mode

OPTIONAL

Fuel Supply

	O.G-ACO-BT-C1900-0600	600 Lt Oversized Fuel Tank on board for SS (30/40 kVA)
	O.G-ACO-BT-C1900-1000	1000 Lt Oversized Fuel Tank on board for SS, RB (30/40 kVA)
	O.G-ACO-GA-01	Mechanical analogue float for internal fuel tank on board
	O.G-ACO-GA-02	Electrical analogue float to monitor the external refilling point on board
	O.G-ACO-RE-01	External refilling point for Gen Sets 10/250 kVA, SS, RB versions
	O.G-ACO-RE-SP-01	External refilling point with warning light for Gen Sets 10/250 kVA, SS, RB versions
	O.G-ACO-SC-AC-EL-01	Diesel heater installed in the tank 220W 230V usable for RB 10/500, SS 130/750 and all oversized tanks (for GE from 10 to 100 KVA SS replace the tank from plastic to metal using the article O.G-ACO-TK-ST -...)
	O.G-ACO-SP-01	Tank leak sensor with signal reported in the QPE/QLE-B control panel
	O.G-ACO-ST-BG-ES1	"Easy" automatic fuel refilling system on board, controlled by QPE-C and QLE-B panels



Alternator

O.G-ALT-SEZ-IT-TN	Disconnecter for IT/TN system installed on the alternator for Gen-sets from 10 to 500 KVA only SS and RB version (check the feasibility)
--------------------------	--

Batteries

	O.G-BAT-BAE-01	Maintenance free high efficiency starter batteries (10/40 kVA)
---	-----------------------	--

Canopy

	O.G-COF-AM-01	Hinges and Doors with tamper-proof device (10/100 kVA)
	O.G-COF-AP-01	Door opening alarm system (each door)
	O.G-COF-DLO-C1750-05KW	Dummy Load 5kW on board for Gen Sets 20 kVA (Add optional O.Q-QPE-RIL-16RELE in case of MC4 control. Add optional O.Q-QBM-COM-BIO8 for Comap AMF25, IG200, IG500 control. For other controls, check with technical department.)

O.G-COF-DLO-C1900-07KW

Dummy Load 7kW on board for Gen Sets 25/30 kVA (Add optional O.Q-QPE-RIL-16RELE in case of MC4 control. Add optional O.Q-QBM-COM-BIO8 for Comap AMF25, IG200, IG500 control. For other controls, check with technical department.)

O.G-COF-DLO-C4700-120KW

Dummy Load 120kW on board for Gen Sets 450/700 kVA (Add optional O.Q-QPE-RIL-16RELE in case of MC4 control. Add optional O.Q-QBM-COM-BIO8 for Comap AMF25, IG200, IG500 control. For other controls, check with technical department.)

O.G-COF-IL-INT-01

Internal LED lighting with micro-switches for Gen Sets 10/250 kVA

O.G-COF-PC-01

Steel cable holder for SS and RB versions from 10 to 40 KVA applied to the radiator inspection panel (Weight 20 Kg)

O.G-COF-TRT-MAR-01

High resistance canopy treatment for corrosive environments for 10/40 kVA (SS, RB Versions)

O.G-COF-VER-PAR-01

Canopy custom paint (Grey base-frame) for 10/40 kVA (SS, RB Versions)

O.G-COF-VER-TOT-01

Total canopy custom paint for 10/40 kVA (SS, RB Versions)

Electrical on board

O.G-MPRB-16A-SCHUKO

16A SCHUKO IP65 socket with magneto-thermal breaker for RB Version

O.G-MPRB-16A3P

16A EC 3P IP65 socket with magneto-thermal breaker

O.G-MPRB-16A5P

16A EC 5P IP65 socket with magneto-thermal breaker for RB Version (specify if 6H or 1H)

O.G-MPRB-32A5P

32A EC 5P IP65 socket with magneto-thermal breaker (specify if 6H or 1H)

O.G-MPRB-AR-AUX-4P

ILME 4 poles connector for connecting the remote signals and/or commands (indicate the functions). Available for the units form 10 up to 500KVA in RB version and +011 variant.

O.G-MPRB-AR-REM-START

Bulgin socket for connecting the remote start/stop contact. Available for the units form 10 up to 500KVA in RB version and +011 variant.

O.G-MPRB-CMT-01

Automatic switching on board for Gen Sets 10/40 kVA RB Version +011 (no additional sockets allowed)

O.G-MPRB-DIF-PR-01

Differential protection for modular switch for 1PH 16/32A socket (specify if 0.3A or 0.03A)

O.G-MPRB-DIF-PR-02

Differential protection for modular switch for 3PH 16/32A socket (specify if 0.3A or 0.03A)

O.G-MPRB-FIX-SCREWS













Fixing sockets on RB module with screws to replace the tear rivets. Only for GE RB version.

O.Q-QBM-CPI-BEN-01

Permanent insulation controller for IT networks up to 230V / 400V. BENDER IR423-D4-1. Adjustable threshold 10 ÷ 300 kohm. (2 DIN rail modules - check feasibility)

O.Q-QLE-K-DIF-M3

Adjustable differential protection only for MC2-PLUS controller for Gen Sets 10/500 kVA (+011 variant)

	O.Q-QMC-K-DIF-R1	Adjustable differential protection only for QMC panel for Gen Sets 10/40 kVA (Variant +010 / +011)
	O.Q-QMC-RX8-QMC	Start-stop radio control with max. radius 500 mt indoors and 5 km outdoors (for QMC panel).
	O.Q-QMC-SAS-01	Auto Start-Stop at load request (QMC panel)
	O.Q-QPE-485.CONV-LAN	Converter 485/LAN for QPE-C, QLE-B panel
	O.Q-QPE-485.CONV-USB	Converter 485/USB for QPE panel
	O.Q-QPE-DIS-MS.01	MASTER/SLAVE device for QPE panel
	O.Q-QPE-INT-CST-01	GE main switch STATUS contact wired to terminal board inside the QPE panel on board generator (10 / 40KVA) (no variant +10)
	O.Q-QPE-K-DIF	Differential protection adjustable for the MC4
	O.Q-QPE-MD-QPE-C	GSM Modem for remote management of the genset through SMS (SIM card not included). Available only for +010/+011 versions with QPE panel.
	O.Q-QPE-POT-VOLT	Internal potentiometer for voltage regulation - available only for variant +10/+11
	O.Q-QPE-PR-QPE-C	Remote panel for QPE-C, QLE-B - available only for variant +10/+11
	O.Q-QPE-QBM-COM-AMF25	Option with QBM COMAP AMF25 controller on board instead of QPE
	O.Q-QPE-QBM-DSE-7320	Option with QBM DSE7320 controller on board instead of QPE.
	O.Q-QPE-RIL-16RELE	16-relay module for QPE panel
	O.Q-QPE-RX8-QPE-C	Start-stop radio control with max. radius 500 mt indoors and 5 km outdoors (for QPE panel).
	O.Q-QPE-SAS-02	Auto Start-Stop at load request (QPE, QLE panels)
	O.Q-QPE-SCD-01	Anti-condensation heater inside the panel
	O.Q-QPE-SEL-2P	2 position selector switch on board cubicle (indicate the function of the selector)
	O.Q-QPE-SEL-3P	3 position selector switch on board cubicle (indicate the function of the selector)
	O.Q-QPE-TG-E-MON-BASIC	GSM/GPS modem for remote management - available only for +010/+011 versionis (complete with antenna and SIM card)

O.Q-QPE-TG-QPE-C

Remote management software via LAN for QPE-C, QLE-B panel compatible with Windows XP up to Windows 10

Engine

O.G-MOT-FC-1

Dust collector filter - for Gen Sets 10/20 kVA

O.G-MOT-FSA-1

Fuel/Water Separator Filter - for Gen Sets 10/20 kVA

O.G-MOT-K-40C-01

Engine liquids suitable for -40°C ambient temperature for Gen Sets 10/40 kVA

O.G-MOT-RF-01

Electronic speed governor for Gen Sets 10/40 kVA

O.G-MOT-SC-AC-EL-01

Engine pre-heater 230V with thermostat on board for Gen Sets 10/100 kVA (BF/PRO/SS/RB)

O.G-MOT-SC-AC-EL-02

Super hot engine heater 230V with thermostat on board for Gen Sets 10/100 kVA

O.G-MOT-SE-LR-01

Radiator coolant level sensor from 10 to 100 Kva

Handling

O.G-MOV-CN-3

Off-road trailer with 2 pneumatic wheels and tow bar (SS, RB Gen Sets 10/40 kVA)

O.G-MOV-CO-RS-02

Spare wheel with support for On road traiver O.G-MOV-CO-RS-02

O.G-MOV-CO-ST-02

Roadworthy trailer (Maximal capacity 1200Kg) 80km/h for genset from 10 to 40 kVA (registration excluded). For ge SS combine with code O.G-MOV-KRM-SS-01

O.G-MOV-KAC-01

Kit of plates for anchoring unit on trailer using belts. Available for gen sets from 10 to 100kVA only SS and RB version.

Quadro bordo GE
O.Q-QBM-BMIN-230V-01

Additional price for 230V minimum voltage coil on the modular main switch inside the control panel (check feasibility)

O.Q-QBM-COM-4G-GPS

Module cellular modem 2G/3G/4G in combination with a GPS/GLONASS receiver per INTELILITE 4 AMF25, AMF8, IG200, IG500 G2 and IG1000





O.Q-QBM-COM-BIO8

BIO8 expansion module for Comap INTELILITE4 AMF25, AMF8, IG200, IG500 G2 and IntelliGen4 200 controllers complete with user terminal block and / or relay for relaying outputs - if used (check installation feasibility in the switchboard).





O.Q-QBM-COM-ETH

Expansion module with ethernet port installed on the INTELILITE 4 AMF25, AMF8, IG200 control board. For connection to PC MOD-BUS TCP / IP - SNMP.

⚙️ Exhaust

	O.G-SCA-CAT-02	Catalytic converter (20 kVA)
	O.G-SCA-FAP-K20	Particulate filter (DPF) for Gen Sets 10/20 kVA
	O.G-SCA-PF-01	Spark arrestor for Gen Sets 10/40 kVA
	O.G-SCA-PR-01	Exhaust pipe protection kit (10/20 kVA) , SS,RB version

⚙️ Test

	MS.CP-LT-01	FAT - Factory Acceptance Test for single Gen Set from 10 to 100 kVA according to our standard procedures in Elcos factory (max 2 hours - max 4 people - max 1 hour of operation)
	MS.CP-SP-01	FAT - Factory Acceptance Test for single custom Gen Set from 10 to 100 kVA max 4 operating hours or parallel system up to 4 units for 1 operating hour, in Elcos factory (max 4 hours - max 4 people)
	MS.CP-ST-01	FAT - Factory Acceptance Test for single Gen Set from 10 to 100 kVA according to our standard procedures in Elcos factory (max 4 hours - max 4 people - max 2 hour of operation)
	MS.RF-ST-01	Noise test report for single Gen Set from 10 to 250 kVA
	MS.TV-ST-01	Vibration test on 10 points with certificate for single Gen Set from 10 to 250 kVA

⚙️ Vari

	O.G-VAR-CAT-01	Toolbox for ordinary maintenance.
	O.G-VAR-PUN-TER-01	Round earth spike, diam. 20 mm, height 1.5mt, galvanized, complete with clamp and 3m yellow/green cable model FS17 1x35mm ² with cable lugs.
	O.G-VAR-PUN-TER-02	Cross-shaped earth spike, height 1.5mt, galvanized, complete with clamp and 3m yellow/green cable model FS17 1x35mm ² with cable lugs.

PRP

Engines of this rating provide unlimited hours of usage in a variable load application. The average load factor should not exceed 70% of the engine's prime power rating with a maximum number of 500 operational hours at 100% prime power rating. An overload capability of 10% is available, however, is limited to a period of 1 in every 12 hours

LTP

Limited-time running power is defined as the maximum power available, under the agreed operating conditions, for which the generating set is capable of delivering for up to 500h of operation per year with the maintenance intervals. The overload is not allowed.

Sheet: C 1900.RB	RENTAL BUILDING	Exhaust side:	Type: STANDARD	Rev: 00	Last Update: Apr 28, 2020	Page 1/2
------------------	-----------------	---------------	----------------	---------	---------------------------	----------

OVERALL DIMENSIONS [mm]

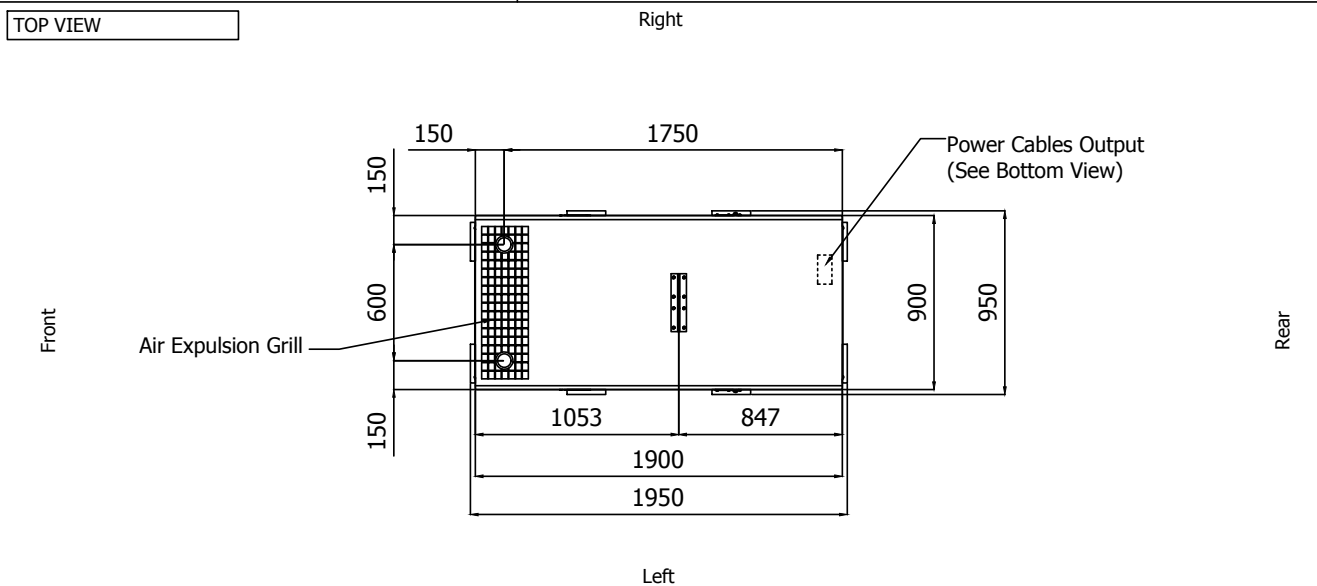
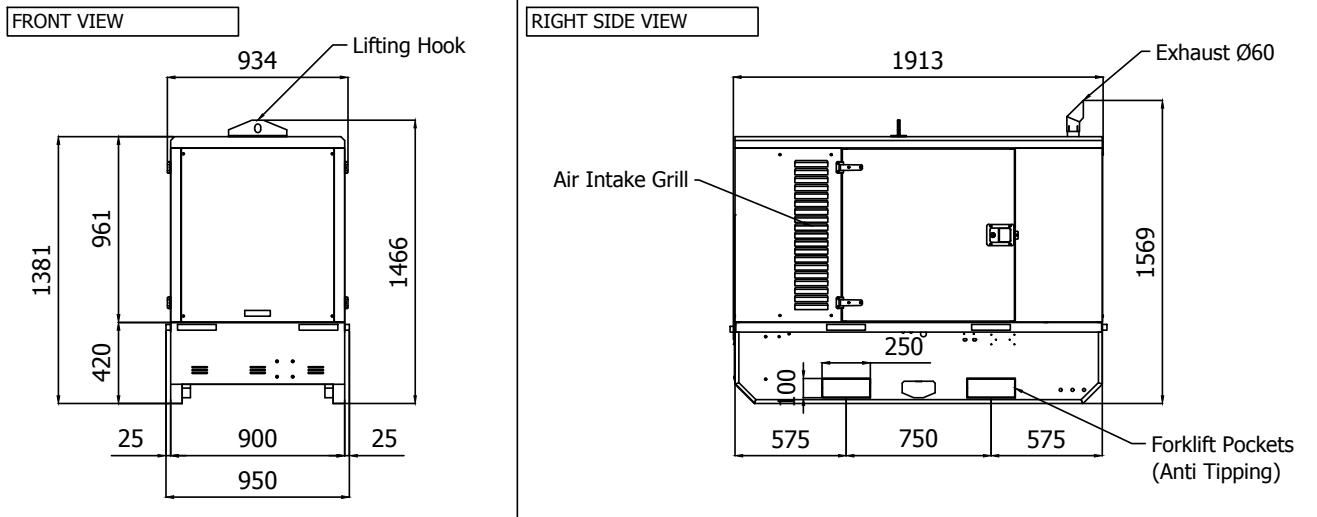
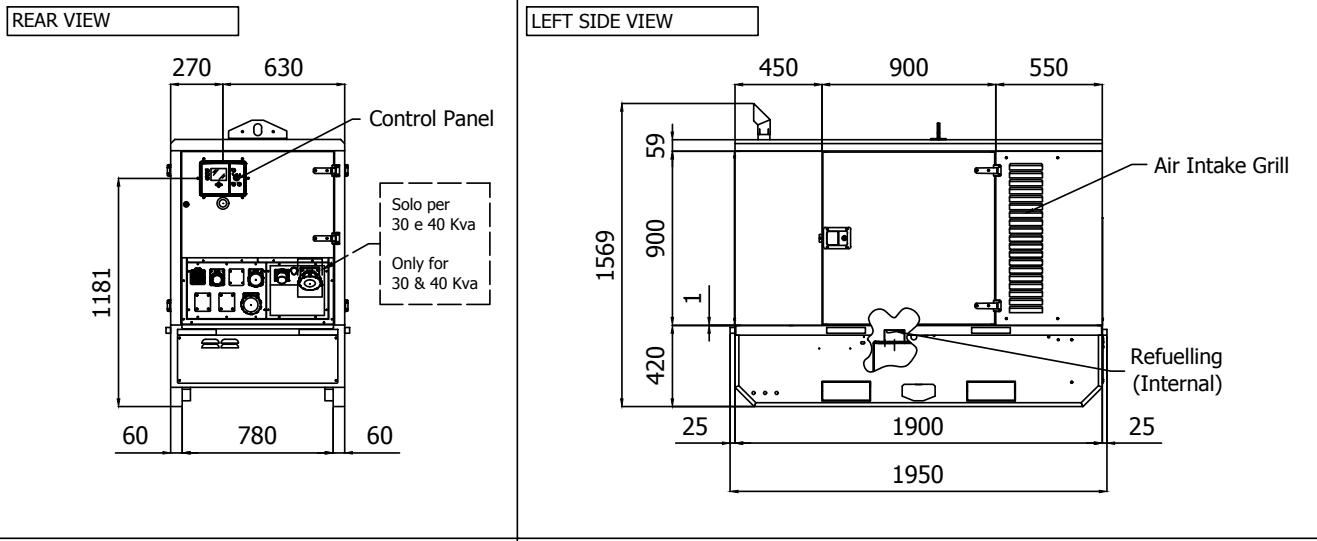

IMPORTANT:

- 1) Form and dimension refer to the generating set on catalogue
- 2) Form and dimension are subject to change in order to update or improve the products
- 3) This document can not be copied or transmitted without ELCOS S.r.l. approval

Data and technical specifications are subject to change in order to update or improve the products

Sheet:	C 1900.RB	RENTAL BUILDING	Exhaust side:	Type:	STANDARD	Rev:	00	Last Update:	Apr 28, 2020	Page 2/2
--------	-----------	-----------------	---------------	-------	----------	------	----	--------------	--------------	----------

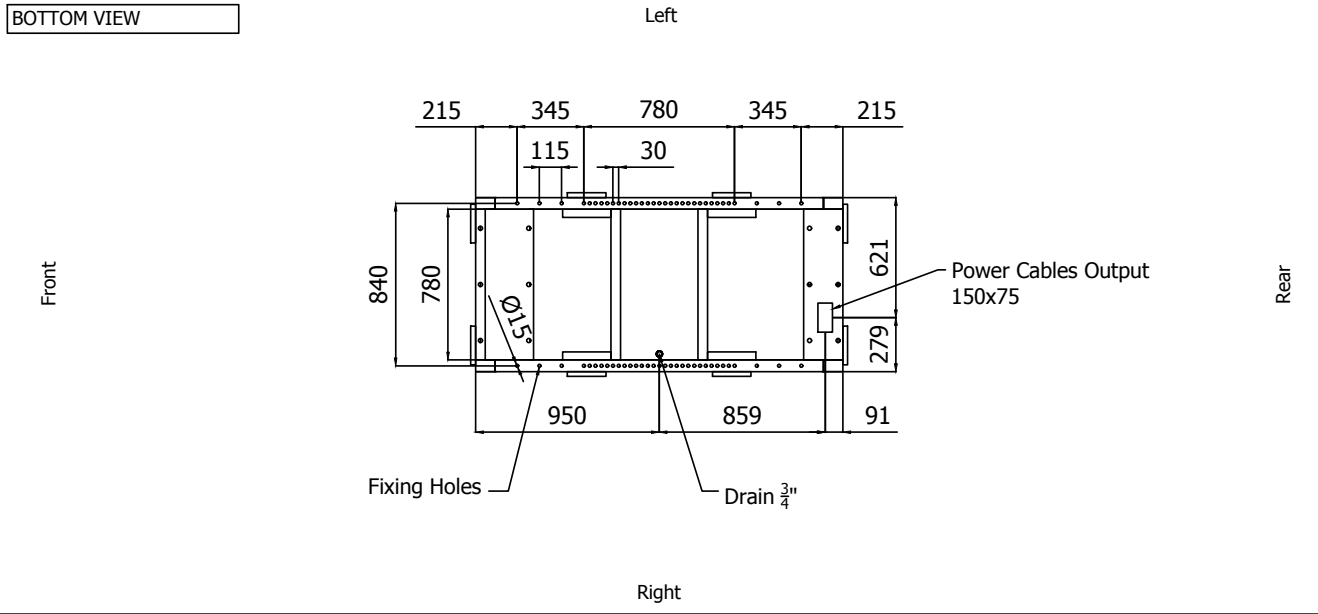

DIMENSIONS WITH OPEN DOORS [mm]

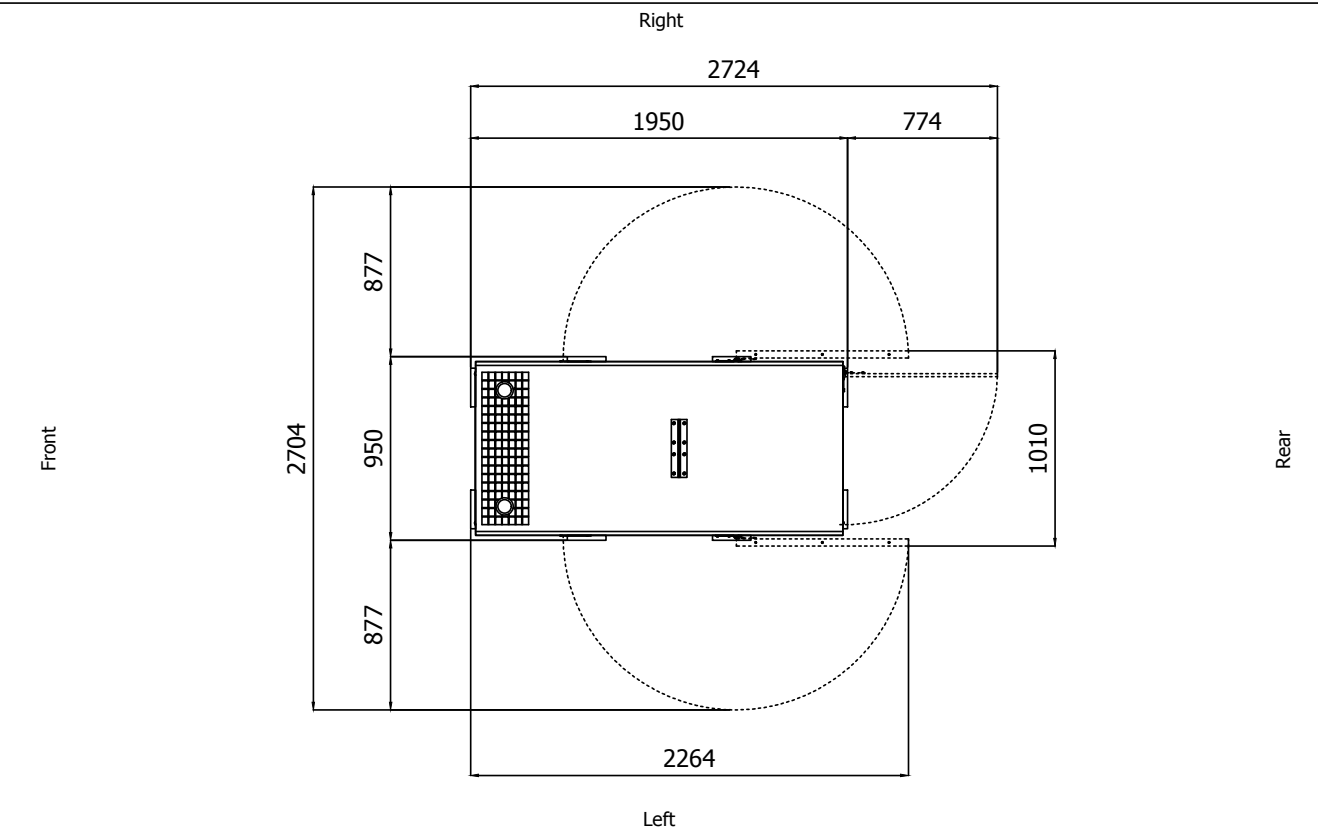

Note: With Lifting-Off Door Solution consider only canopy dimensions.
(Models with "Control Panel" behind rear door will mount a special cover to protect it)

VENTILATION OF THE ROOM

The windows area in the generating set room needs to be (recommended):
Aspiration: 0.30 m²
Expulsion: 0.20 m²
ATTENTION: for a correct ventilation the expulsion air and the exhaust gas needs to be conveyed in the open-air

- IMPORTANT:**
- 1) Form and dimension refer to the generating set on catalogue
 - 2) Form and dimension are subject to change in order to update or improve the products
 - 3) This document can not be copied or transmitted without ELCOS S.r.l. approval